

PFAFF

creative 2134

german engineering

Ersatzteile-Liste
List of spare parts
Liste des pièces détachées
Catalogo pezzi staccati
Lista de piezas de repuesto

Nicht nummerierte Teile im Katalog werden nicht geliefert.

The parts mentioned without number in the parts list are not available.

Les pièces qui ne sont pas numérotées dans la liste de pièces détachées ne peuvent être livrées.

Pezzi non catalogati non sono disponibili.

Las piezas de repuesto sin número en esta lista no se entregarán.

Bei Bestellung von Ersatzteilen muss die Modell-Nr. der Maschine, die Seitenzahl des Kataloges und die Teilenummer angegeben werden.

Die Verschleißteile-Nummern sind in der Teileliste unterstrichen.

When ordering spare parts, please state the model number, the page number in the catalogue of spare parts and the number of the parts called for.

The wear and tear part numbers are **underlined** in the parts list.

Prière d'indiquer dans vos commandes de pièces de rechange, le numéro de la machine, le numéro de la page dans la liste des pièces détachées, ainsi que les numéros des pièces commandées.

Les numéros de pièces d'usure sont **imprimés soulignés** dans la liste des pièces.

La richiesta dei pezzi di ricambio deve contenere il modello della macchina, la pagina del catalogo e il codice del pezzo.

I codini dei pezzi d'usura sono quelli **sottolineati** nel catalogo.

Al pedir piezas, sírvanse de indicar el número del modelo de la máquina, la página de la lista de piezas de repuestos y el número de la pieza deseada.

Los números de las piezas de desgaste están **subrayadas** en la lista.

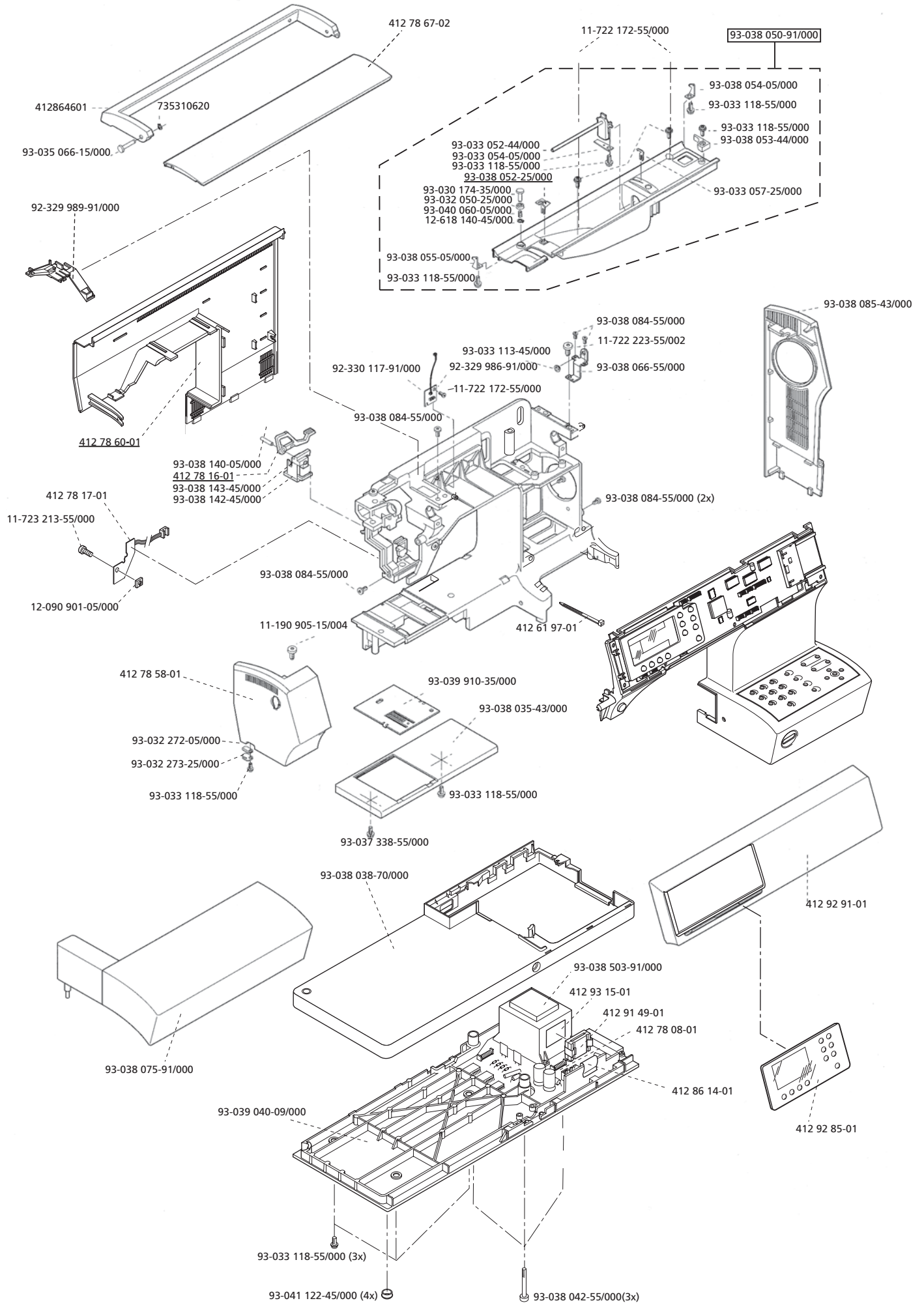

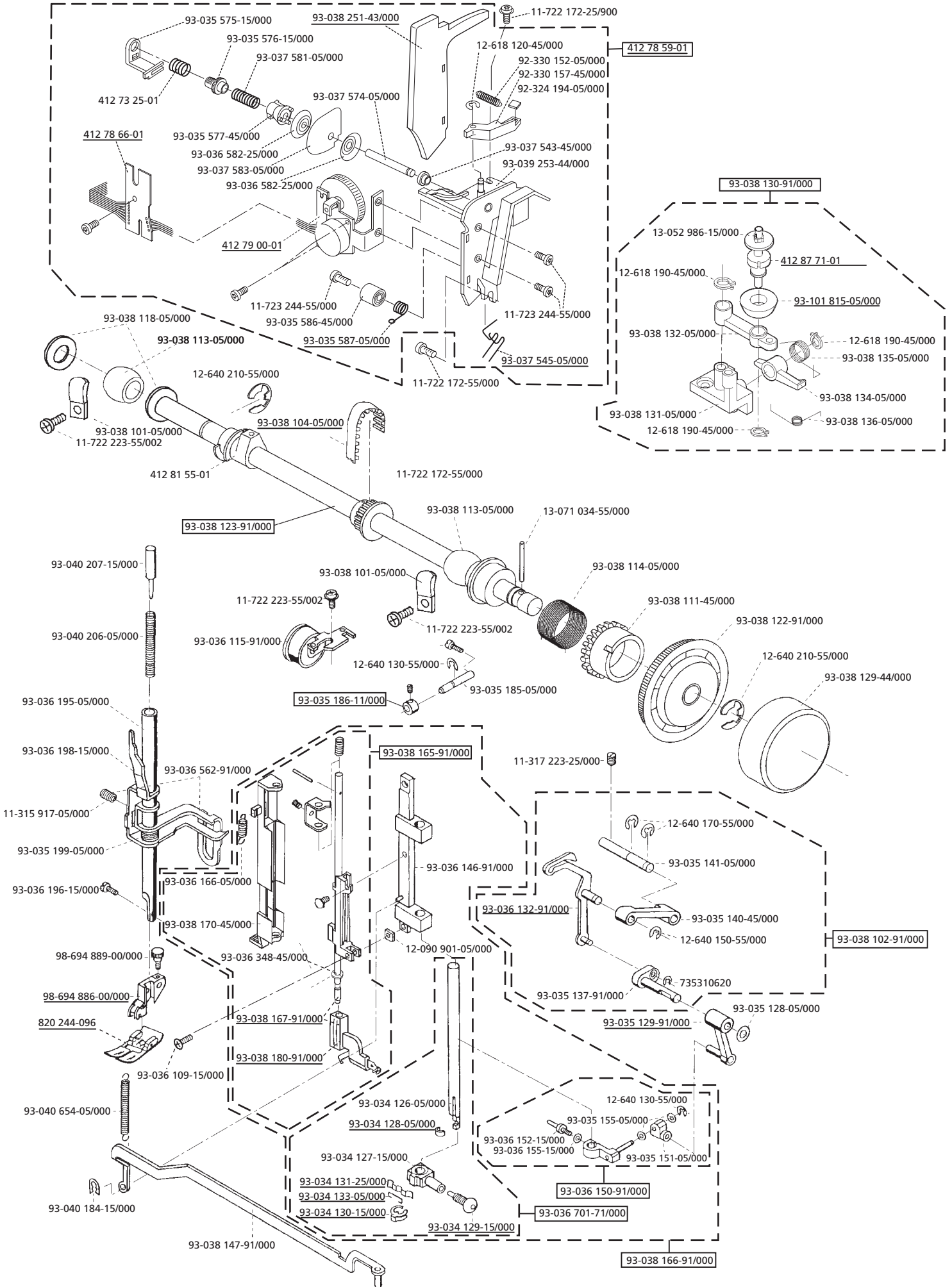

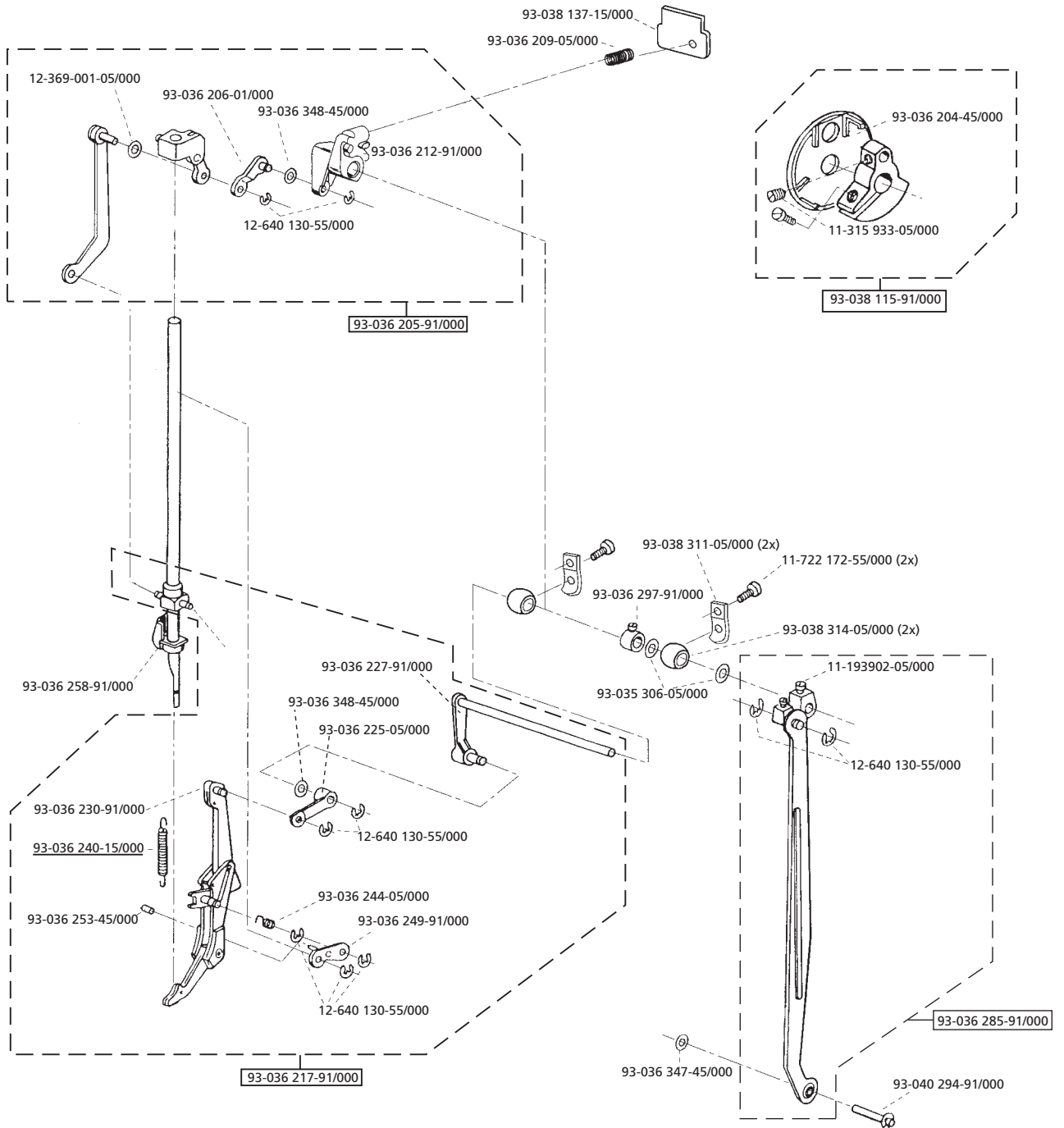

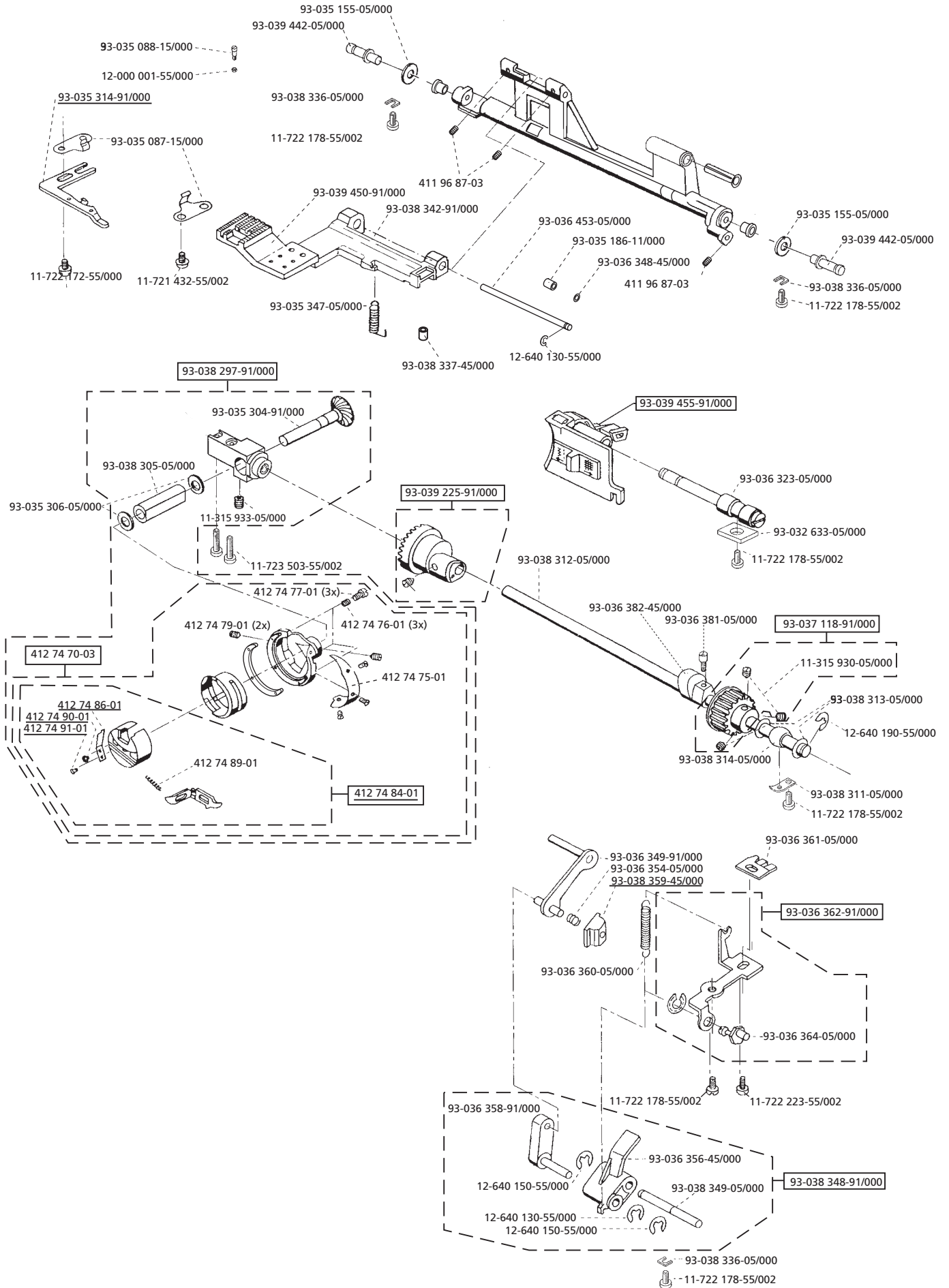

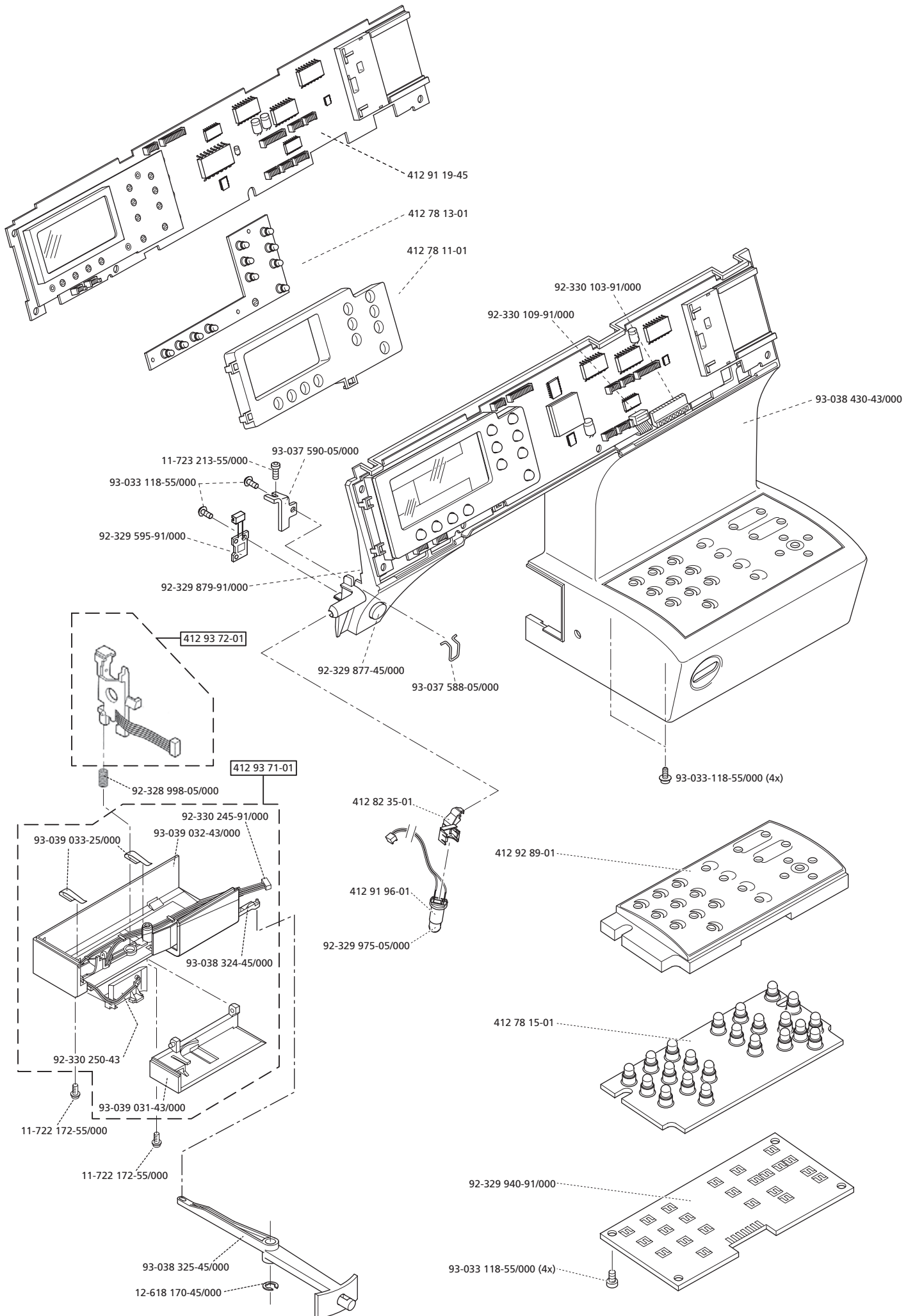

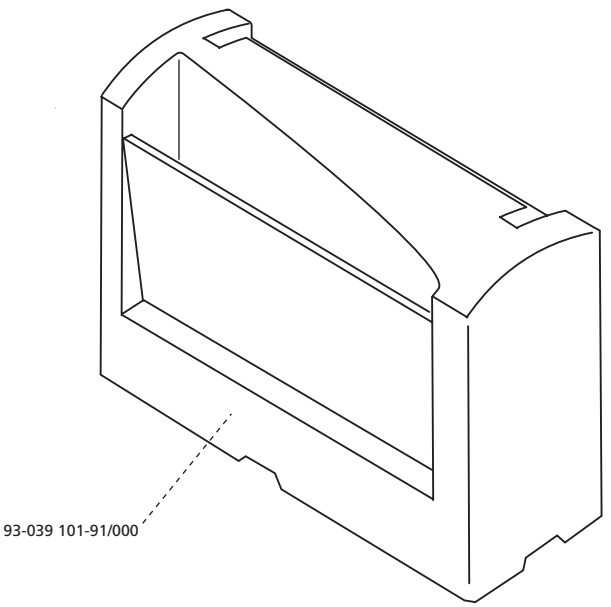
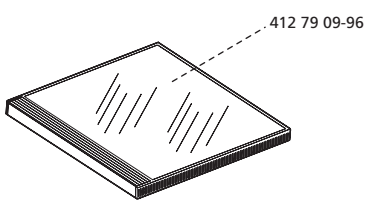
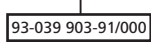
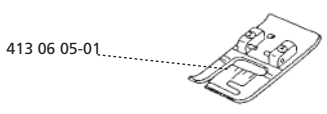
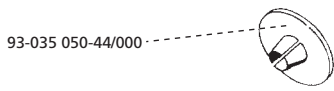
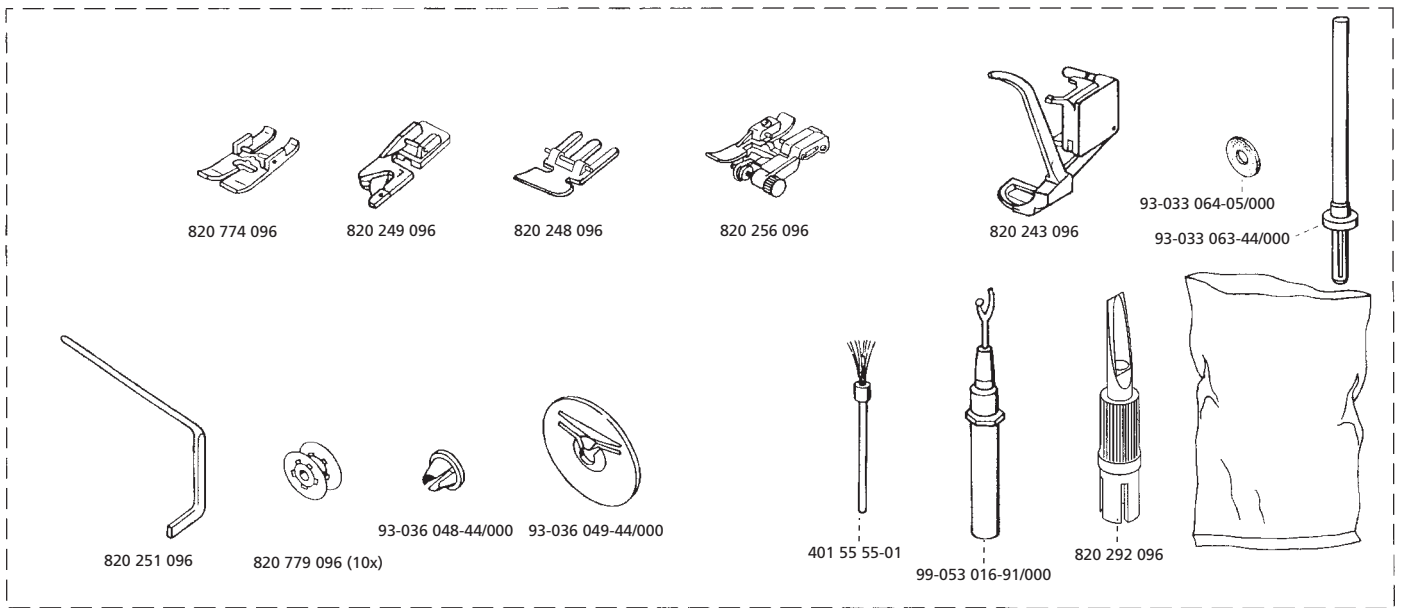

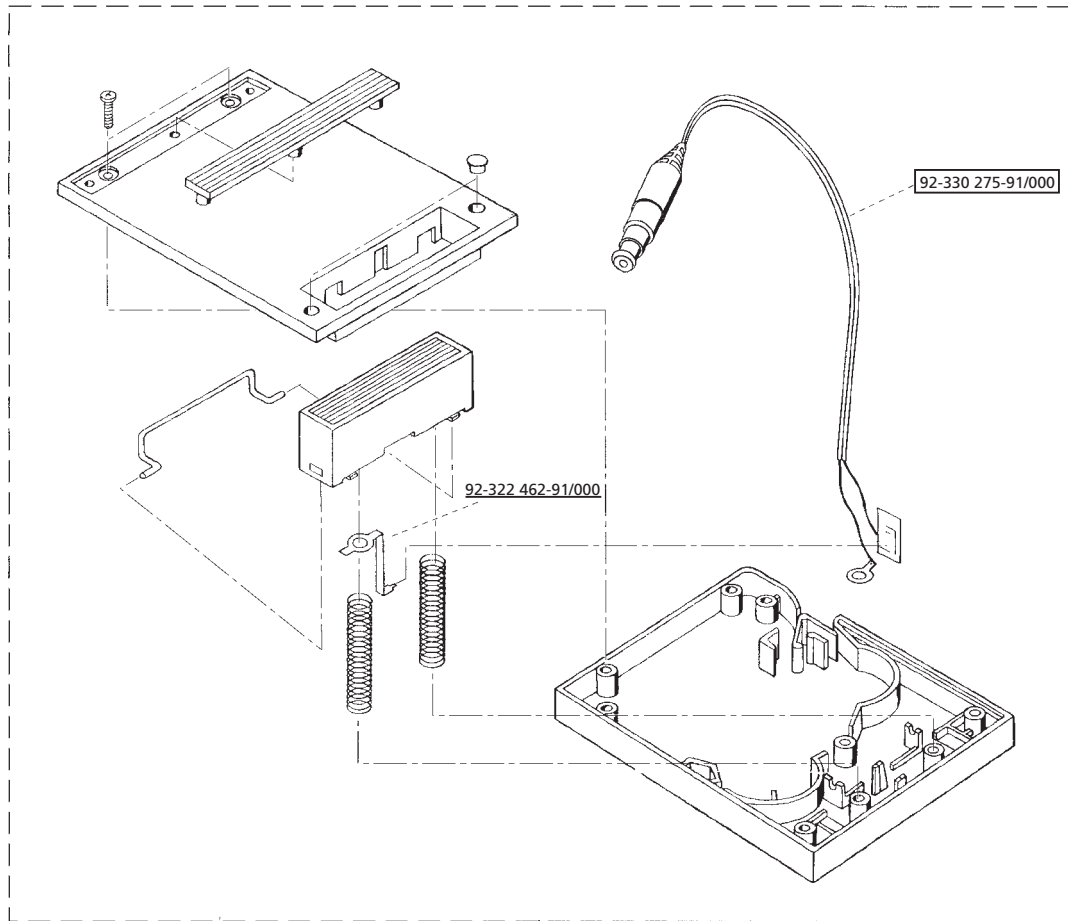
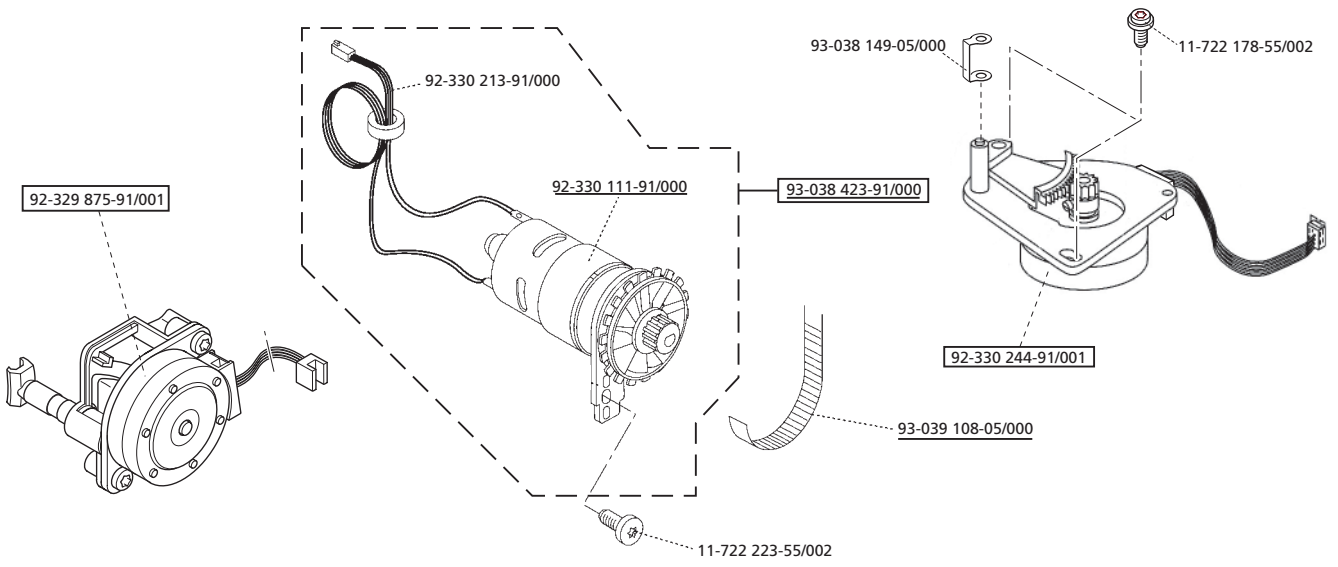

- 412 15 81-02 SSA
- 70-332 774-14/000 BEAB
- 412 15 78-01 VDE
- 412 15 79-03 UL/CSA

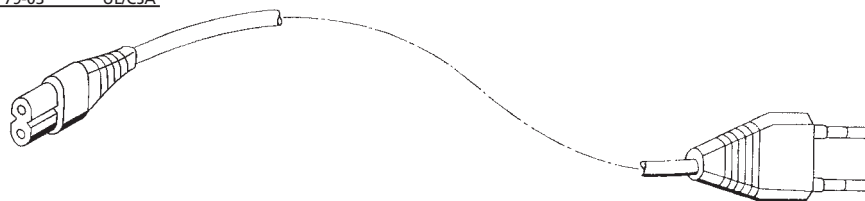



820 666 096



820 274 096 (Ø 6 mm)
820 273 096 (Ø 4 mm)



820 214 096

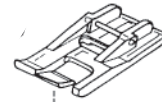

739303303608



820 276 096

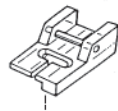

820 790 096

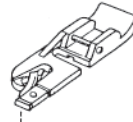

820 220 096

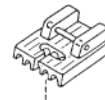

820 226 096



820 664 096 (6mm)
Teflon



820 245 096

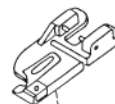

820 926 096

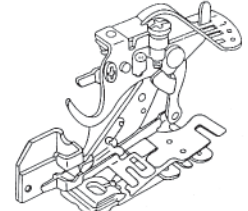

820 255 096



820 211 096



820 212 096



820 215 096



820 364 096
Metall, metal

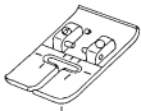

820 277 096 (9mm)
Teflon



820 609 096



820 608 096



820 607 096



820 544 096

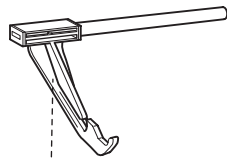

820 279 096

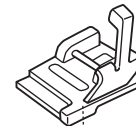

820 668 096

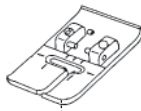

820 777 096

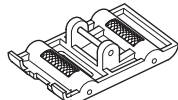

820 663 096

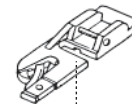

820 249 096

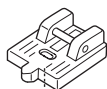

820 474 096

Stickaggregat RA 3022, Embroidery Unit RA 3022

412 69 95-01

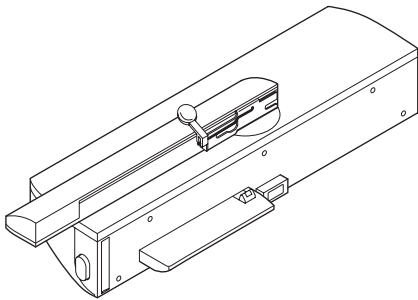
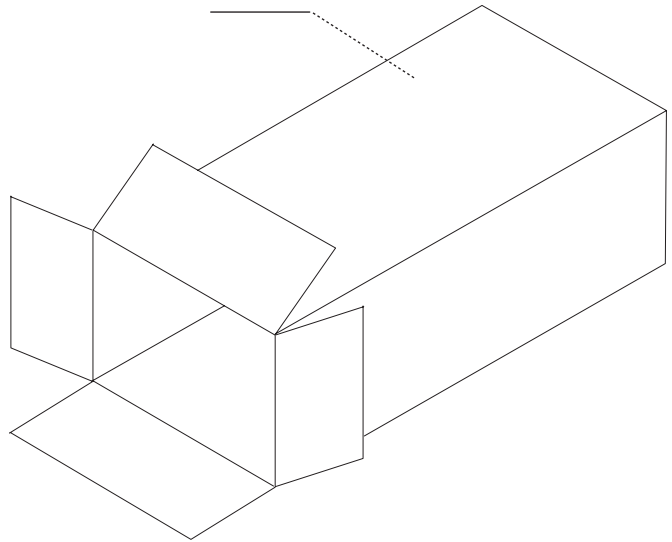

93-039 351-05/000

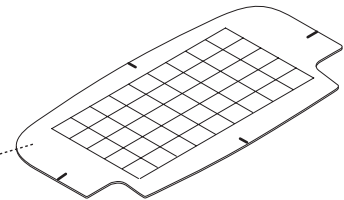

412 65 18-04

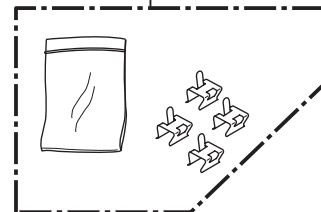

820 28 00-96

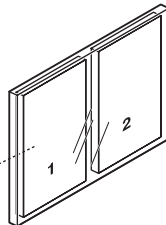

412 78 87-02

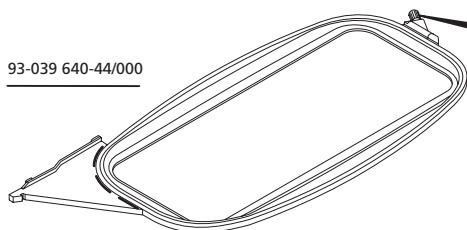

93-039 640-44/000

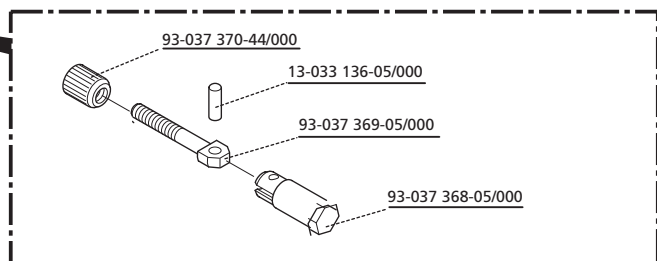

93-037 370-44/000

13-033 136-05/000

93-037 369-05/000

93-037 368-05/000

NOTIZEN, NOTES, NOTES, NOTE, NOTAS:

Nummernverzeichnis • Numerical Index • Index • Elenco dei Numeri • Índice numérico

	Bezeichnung	Description	Seite / page
11-190 905-15/004	SHR D7985-M5x10-Z1	screw D7985-M5x10-Z1	1
11-193 902-05/000	SHR AM4x5,5 N11193	screw AM4x5,5 N11193	3
11-315 917-05/000	Gewindestift PH 11315-B-M6x0,75x6	set screw PH 11315-B-M6x0,75x6	2
11-315 930-05/000	Gewindestift PH 11315-B-M6x0,75x3,5	set screw PH 11315-B-M6x0,75x3,5	4
11-315 933-05/000	Gewindestift PH 11315-B-M6x0,75x5	set screw PH 11315-B-M6x0,75x5	3, 4
11-317 223-25/000	Gewindestift ISO 4766-M5x10	set screw ISO 4766-M5x10	2
11-330 082-05/000	Gewindestift DIN 913-M3x3	set screw DIN 913-M3x3	4
11-721 432-55/002	SHR D7500-BE-M4x6	screw D7500-BE-M4x6	4
11-722 172-25/900	SHR PN11722-M4x8 m. Scheibescrew	PN11722-M4x8 with disk	2
11-722 172-55/000	SHR PN11722-M4x8	screw PN11722-M4x8	1, 2, 3, 4, 5
11-722 178-55/002	SHR PN11722-M4x12	screw PN11722-M4x12	4, 7
11-722 223-55/002	SHR PN 11722-M5x10	screw PN11722-M5x10	2
11-722 223-55/002	SHR PN11722-M5x10	screw PN11722-M5x10	1, 2, 4, 7
11-723 213-55/000	Schraube M3x6	screw M3x6	1, 5
11-723 244-55/000	SHR PN11723-CE-M3x12	screw PN11723-CE-M3x12	2
11-723 503-55/002	SHR PN11723-C-M4x20	screw PN11723-C-M4x20	4
12-000 001-55/000	Mutter ISO 10511-M3	nut ISO 10511-M3	4
12-090 901-05/000	Mutter M3 DIN 562	nut M3 DIN 562	1, 2
12-369 001-05/000	Scheibe 4,6x6,7 PH12369	washer 4,6x6,7 PH12369	3
12-618 120-45/000	Ring PN12618-3	grip ring PN12618-3	2
12-618 140-45/000	Ring PN12618-3,5	grip ring PN12618-3,5	1
12-618 170-45/000	Ring PN12618-5	grip ring PN12618-5	5
12-618 190-45/000	Ring PN12618-6	grip ring PN12618-6	2
12-640 130-55/000	Sicherungsscheibe DIN 6799-3,2	retaining washer DIN 6799-3,2	2, 3, 4
12-640 150-55/000	Sicherungsscheibe DIN 6799-4	retaining washer DIN 6799-4	2, 4
12-640 170-55/000	Sicherungsscheibe DIN 6799-5	retaining washer DIN 6799-5	2
12-640 190-55/000	Sicherungsscheibe DIN 6799-6	retaining washer DIN 6799-6	4
12-640 210-55/000	Sicherungsscheibe DIN 6799-8	retaining washer DIN 6799-8	2
<u>13-033 136-05/000</u>	Zyl. Stift ISO 8734-2,5x6	pin ISO 8734-2,5x6	9
13-052 986-15/000	Spannstift ISO 8750-1x5	tightening pin ISO 8750-1x5	2
13-071 034-55/000	Kerbstift ISO 8742-3x24	slotted pin ISO 8742-3x24	2
401 55 55-01	Pinsel	soft brush	6
411 96 87-03		Screw M3x3 TX	4
412 15 78-01	Anschlussltg. PH 73327-220V	connect. cable PH 73327-220V	7/VDE
412 15 79-03	US Kabel RAL 7035	US cable RAL 7035	7 UL/CSA
412 61 97-01	Kabelbinder-Standard 2,5x98	cable clip - standard 2,5x98	1
412 65 18-04	Federclipse	clips	9
<u>412 69 95-01</u>	Versandschachtel	box	9
412 73 25-01	Zyl. Druckfeder	compression spring	2
<u>412 74 70-03</u>	Greifer kpl.	hook cpl.	4
412 74 75-01	Fadenabziehkurve	thread pulling cam	4
412 74 76-01	Zyl. Druckfeder	helical compression spring	4
<u>412 74 77-01</u>	Fl. Kopfschraube m. Ansatz	pan head screw with shoulder	4
412 74 79-01	Gewindestift	set screw	4
412 74 80-01	Spulenkapselträger	Bobbin case holder	4
<u>412 74 84-01</u>	Spulenkapsel kpl.	bobbin case cpl.	4
<u>412 74 86-01</u>	Blattfeder	plate spring	4
412 74 89-01	Zyl. Druckfeder	helical compression spring	4
<u>412 74 90-01</u>	Stellschraube a	djustion screw	4
<u>412 74 91-01</u>	Linsensenkschraube	raised countersunk head screw	4
412 78 08-01	LP-Netzteil best.	PCB power supply assembled	1
<u>412 78 11-01</u>	Niederhalter	holder frame	5
<u>412 78 13-01</u>	Schaltmatte	keypad	5
412 78 15-01	Schaltmatte	keypad	5
412 78 17-01	Leiterplatte kpl.	PC-board cpl.	1
<u>412 78 16-01</u>	Lüfterhebel	foot lifter	1

	Bezeichnung	Description	Seite / page
<u>412 78 58-01</u>	Kopfdeckel bedr.	head cover printed	1
<u>412 78 59-01</u>	Fadenspannung kpl.	thread tension cpl.	2
<u>412 78 60-01</u>	Schale hinten bedr.	rear cover printed	1
<u>412 78 66-01</u>	Leiterplatte kpl.	printed circuit cpl.	2
<u>412 78 67-02</u>	Armdeckel kpl.	arm cover cpl.	1
<u>412 78 87-02</u>		creative SmartCard cpl.	9
<u>412 78 59-01</u>	Schrittmotor kpl.	step motor cpl.	2
<u>412 79 09-96</u>	Instruktions CD	instruction CD	6
<u>412 81 55-01</u>	Taktgeber kpl.	impulser cpl.	2
<u>412 82 35-01</u>	Lampenhalter	lamp holder	5
<u>412 86 14-01</u>	Clip	clip	1
<u>412 86 46-01</u>	Griff	handle	1
<u>412 87 71-01</u>	Spulerspindel kpl.	bobbin winder spindle cpl.	2
<u>412 91 19-45</u>		control board 2134	5
<u>412 91 49-01</u>	Ferritkern	Ferrit core	1
<u>412 91 96-01</u>	Nähleuchte NV kpl.	sewing lamp cpl.	5
<u>412 92 85-01</u>	Bedienfeldblende bedr.	control panel frame printed	1
<u>412 92 89-01</u>	Programmblende bedr.	program panel printed	5
<u>412 92 91-01</u>	Frontblende bedr.	front blind printed	1
<u>412 93 15-01</u>	beidseitiges Klebeband	Double stick tape	1
<u>412 93 71-01</u>	Freiarmdeckel kpl.	free arm cover cpl.	5
<u>412 93 72-01</u>	Lichtschrankenhalter kpl.	light barrier holder cpl.	5
<u>412 15 81-02</u>	Anschlussltg. PH 73327-SAA	connecting cable PH 73327-SAA	7 / SAA
<u>413 06 05-01</u>	Zierstichfuß kpl.	fancy stitch foot cpl.	6
<u>413 22 65-01</u>		Foot control	7
<u>416 32 90-01</u>		Knife cover	1
<u>7033277414000</u>	Anschlussltg. PH 73327-A3-G	connect. cable PH 73327-A3-G	7/BEAB
<u>735310620</u>	Sicherungsscheibe DIN 6799-2,3 retaining	washer DIN 6799-2,3	1, 2
<u>739303303608</u>	Kapper kpl. 6,5 mm	felling foot 6,5 mm	8
<u>820 212 096</u>	Quilt. & Patchworkfuß kpl. ohne IDT	quilt & patchwork foot cpl. without IDT	8
<u>820 214 096</u>	Applikationsfuß kpl.	applique foot cpl.	8
<u>820 215 096</u>	Applikationsfuß kpl. 9 mm	applique foot cpl. 9 mm	8
<u>820 220 096</u>	Rollsäumer 2 mm	roll hemmer 2 mm	8
<u>820 221 096</u>	Säumer mit IDT	hemmer with IDT	8
<u>820 226 096</u>	Biesenfuß kpl. 5 Rillen	cording foot cpl. 5 cords	8
<u>820 280 096</u>	Stickfuß kpl.	embroidery foot cpl.	9
<u>820 243 096</u>	Stopffuß kpl.	darning foot cpl.	6
<u>820 244 096</u>	Zickzackfuß kpl.	zigzag foot cpl.	2
<u>820 245 096</u>	Schrägbandeinfasser	bias tape binder	8
<u>820 248 096</u>	Reißverschlussfuß	zipper foot	6
<u>820 249 096</u>	Säumer	roll hemmer foot	6,8
<u>820 251 096</u>	Lineal	quilter guide	6
<u>820 255 096</u>	Mehrstichkräusler	multi-stitch gathering foot	8
<u>820 256 096</u>	Blindstichfuß kpl. f. Obertransp.	blind stitch foot cpl. for IDT	6
<u>820 273 096</u>	Lochstickplatte 4 mm	eyeletting plate 4 mm	8
<u>820 274 096</u>	Lochstickplatte 6 mm	eyeletting plate 6 mm	8
<u>820 276 096</u>	Rundlochstickplatte	needle plate (straight stitch)	8
<u>820 279 096</u>	Quiltführung	quilt guide	8
<u>820 292 096</u>	Lampenwechsler	lamp changer cpl.	6
<u>820 364 096</u>	Spule	bobbin	8
<u>820 474 096</u>	Reißverschlussfuß kpl. (verdeckt)	invisible zipper foot cpl.	8
<u>820 544 096</u>	Freihand-Quiltfuß kpl.	freehand-quilting foot cpl.	8
<u>820 607 096</u>	Litzenfuß kpl.	open toe free-motion foot	8
<u>820 608 096</u>	7/9-Lochfuß kpl.	7/9-hole cord foot with IDT	8
<u>820 609 096</u>	Schmalkantenfuß kpl.	narrow edge foot cpl.	8
<u>820 663 096</u>	Rollenfuß	roller foot	8

	Bezeichnung	Description	Seite / page
820 664 096	Spezialgleitsohle kpl.	non stick foot with IDT	8
820 666 096		Three groove cording foot	8
820 668 096	Kräuselfuß Metall kpl.	gathering foot metal	8
820 774 096	Zierstichfuß kpl.	fancy stitch foot cpl.	6
820 777 096	Zierstichgleitsohle	non stick decorative stitch foot without IDT	8
820 788 096	Kapper kpl. 4,5 mm	felling foot 4,5 mm	8
820 779 096	Spule	bobbin	6
820 790 096	Strickkantenfuß kpl.	knit-edge foot cpl.	8
820 926 096		1/4" quilting foot with IDT	8
902-2207-001/000	Fußanlasser AT 0070	foot controller AT 0070	7
<u>92-322 462-91/000</u>	Kontaktfeder kpl.	contact spring	7
92-324 194-05/000	Magnet	magnet	2
92-328 998-05/000	Zylinderdruckfeder	compression spring	5
92-329 595-91/000	Träger kpl.	bracket cpl.	5
92-329 875-91/001	Schrittmotor kpl. TR	motor bracket cpl. TR	7
92-329 877-45/000	Rückwärtstaste bedr.	reverse-feed control printed	5
92-329 879-91/000	Leiterplatte best.	printed circuit cpl.	5
92-329 940-91/000	Leiterplatte	printed circuit	5
<u>92-329 975-05/000</u>	Bajonett-Lampe	bayonet lamp	1
92-329 986-91/000	LP-Taktgeber best. 2-fach	PCB-impulser cpl. double	1
92-329 989-91/000	Kabelführung	cable guide	1
92-330 103-91/000	Flachbandleitung	ribbon cable	5
92-330 109-91/000	Flachbandleitung	ribbon cable	5
<u>92-330 111-91/000</u>	Antriebsmotor	main motor	7
92-330 117-91/000	LP-Taktgeber best. 3-fach	PCB-impulser cpl. triple	1
92-330 152-05/000	Zugfeder	tention spring	2
92-330 157-45/000	Spannungsauslösehebel	tension release lever	2
92-330 213-91/000	Motorleitung	motor cable	7
92-330 244-91/001	Schrittmotor kpl. ZZ	step motor cpl. ZZ	7
92-330 245-91/000	Flachbandltg. kpl.	ribbon cable cpl.	5
92-330 250-43/000	Diodenhalterung	diode bracket	5
92-330 275-91/000	Anlasserleitung kpl.	foot control cable cpl.	7
93-030 174-35/000	Fadenführungsstift	thread guide pin	1
93-032 050-25/000	Fadenführung	thread guide	1
93-032 272-05/000	Messer	knife	1
93-032 633-05/000	Scheibe	washer	4
<u>93-033 052-44/000</u>	Garnrollenstift	spool pin	1
93-033 054-05/000	Feder	spring	1
<u>93-033 057-25/000</u>	Fadenführung	thread guide	1
93-033 063-44/000	Garnrollenstift	spool pin	6
93-033 064-05/000	Filzscheibe	felt washer	6
93-033 113-45/000	Buchse	sleeve	1
93-033 118-55/000	Schraube 3x8	screw 3x8	1, 5
93-034 126-05/000	Nadelstange	needle bar	2
93-034 127-15/000	Nadelhalter	needle holder	2
<u>93-034 128-05/000</u>	Druckstück	transmitting piece	2
<u>93-034 130-15/000</u>	Nadelhalterclips	needle holder clip	2
<u>93-034 131-25/000</u>	Fadenführung	thread guide	2
<u>93-034 133-05/000</u>	Fadenbremse	thread retainer	2
93-035 050-44/000	Fadenabziehscheibe	thread pull-off disk	6
93-035 066-15/000	Sicherungsbolzen	safety bolt	1
93-035 087-15/000	Blattfeder	plate spring	4
93-035 088-15/000	Exzenterbolzen	excentric bolt	4
93-035 128-05/000	Anlaufscheibe	thrust washer	2
<u>93-035 129-91/000</u>	Pleuel kpl.	connecting rod cpl.	2
93-035 137-91/000	Kurbelbolzen kpl.	crank bolt, finished	2

	Bezeichnung	Description	Seite / page
93-035 140-45/000	Schwinge	floating lever	2
93-035 141-05/000	Bolzen	bolt	2
93-035 151-05/000	Gelenkstück	joint piece	2
93-035 155-05/000	Anlaufscheibe	thrust washer	2, 4
93-035 185-05/000	Bolzen	bolt	2
93-035 186-11/000	Stelling kpl.	collar cpl.	2, 4
93-035 199-05/000	Zyl. Druckfeder	helical compression spring	2
<u>93-035 304-91/000</u>	Kegelrad, getrieben	bevel wheel, driven	4
93-035 306-05/000	Anlaufscheibe	thrust washer	3, 4
<u>93-035 314-91/000</u>	Spulenkapselhalter	bobbin case position finger	4
93-035 347-05/000	Zyl. Zugfeder	tension spring	4
93-035 575-15/000	Führung	guide	2
93-035 576-15/000	Buchse	regulating sleeve	2
93-035 577-45/000	Druckstück	transmitting piece	2
93-035 586-45/000	Anschlaghülse	buffer sleeve	2
<u>93-035 587-05/000</u>	Fadenanzugsfeder	thread check spring	2
93-036 048-44/000	Fadenabziehscheibe	thread pull-off disk	6
93-036 049-44/000	Fadenabziehscheibe	thread pull-off disk	6
93-036 109-15/000	Lintenschraube	raised cheese head screw	2
93-036 115-91/000	Winkel mit Spannrolle	tension roll with bracket	2
<u>93-036 132-91/000</u>	Fadenhebel kpl.	take-up lever cpl.	2
93-036 146-91/000	Pendel kpl. (f. die Nadelstange)	pendulum cpl. (for the needle bar)	2
93-036 150-91/000	Kreuzkopf kpl.	cross head cpl.	2
93-036 152-15/000	Klemmbolzen zum Kreuzkopf	clamping bolt to cross head	2
93-036 155-15/000	Scheibe	washer	2
93-036 166-05/000	Zyl. Zugfeder	tension spring	2
93-036 195-05/000	Stoffdrückerstange	presser bar	2
93-036 196-15/000	Schraube	screw	2
93-036 198-15/000	Hebel	lever	2
93-036 204-45/000	Hubexzenter	feed lifting	3
93-036 205-91/000	Hubgetriebe kpl.	lifting gear cpl.	3
93-036 206-01/000	Zugstange kpl.	connecting rod cpl.	3
93-036 209-05/000	Zyl. Druckfeder	helical compression spring	3
93-036 212-91/000	Schwinge kpl.	floating lever cpl.	3
93-036 217-91/000	Schubgetriebe kpl.	shear gear cpl.	3
93-036 225-05/000	Gelenk	joint	3
93-036 227-91/000	Schubwelle mit Kurbel	shear shaft with crank	3
93-036 230-91/000	Transporthebel kpl.	top feed lever with foot cpl.	3
<u>93-036 240-15/000</u>	Zyl. Zugfeder	tension spring	3
93-036 244-05/000	Schenkelfeder	torsion spring	3
93-036 249-91/000	Gelenk kpl.	joint cpl.	3
93-036 253-45/000	Schlauch	hose	3
93-036 257-05/000	Kreuzkopf	cross head	3
93-036 258-91/000	Führung kpl.	guide cpl.	3
93-036 285-91/000	Zugstange mit Kurbel	connecting rod with crank	3
93-036 297-91/000	Stelling kpl.	collar cpl.	3
93-036 323-05/000	Exzenterbolzen	eccentric bolt	4
93-036 347-45/000	Distanzscheibe	distance washer	3
93-036 348-45/000	Anlaufscheibe	buffer disk	2, 3, 4
93-036 349-91/000	Schubstange kpl.	connecting rod cpl.	4
93-036 354-05/000	Zyl. Druckfeder	helical compression spring	4
93-036 356-45/000	Nockenhebel	cam lever	4
93-036 358-91/000	Lenker kpl.	guide cpl.	4
93-036 360-05/000	Zyl. Zugfeder	tension spring	4
93-036 361-05/000	Klemmfeder	clamp spring	4
93-036 362-91/000	Haltewinkel kpl.	angular bracket cpl.	4

	Bezeichnung	Description	Seite / page
93-036 364-05/000	Einstellxcenter	setting eccentric	4
93-036 381-05/000	Zapfenschraube	trunnion screw	4
93-036 382-45/000	Schiebeexcenter	sliding eccentric	4
93-036 453-05/000	Welle	shaft	4
93-036 562-91/000	Führung kpl.	guide	2
93-036 582-25/000	Spannungsscheibe	tension disk	2
93-036 701-71/000	Nadelstange kpl.	needle bar cpl.	2
<u>93-034 129-15/000</u>	Nadelhalterschraube kpl.	needle holder screw cpl.	2
93-037 118-91/000	Zahnscheibe unten	studded disk below	4
93-037 338-55/000	Schraube	screw	1
<u>93-037 368-05/000</u>	Gleitstück	sliding piece	9
<u>93-037 369-05/000</u>	Augenschraube	eyebolt	9
<u>93-037 370-44/000</u>	Rändelmutter	knurl nut	9
93-037 543-45/000	Lager	Bearing	2
<u>93-037 545-05/000</u>	Umlenkbügel	thread guide	2
93-037 574-05/000	Führungsbolzen	guide bolt	2
93-037 581-05/000	Zyl. Druckfeder	compression spring	2
93-037 583-05/000	Mittlere Scheibe	central tension disk	2
93-037 588-05/000	Fadenführungsbügel	thread guide frame	5
93-037 590-05/000	Abstützwinkel	supporting bracket	5
93-038 035-43/000	Freiarmabdeckung	free arm cover	1
93-038 038-70/000	Abdeckung (zur Bodenplatte)	cover (for base plate)	1
93-038 042-55/000	Schraube	screw	1
93-038 050-91/000	Gehäuseeinlage kpl.	housing insert cpl.	1
<u>93-038 052-25/000</u>	Fadenführung	thread guide	1
<u>93-038 053-44/000</u>	Anschlag	stopp	1
93-038 054-05/000	Winkel, rechts	bracket right	1
93-038 055-05/000	Winkel, links	bracket left	1
93-038 066-55/000	Winkel	bracket	1
93-038 075-91/000	Schwenktisch kpl.	swivel table cpl.	1
93-038 084-55/000	Ansatzschraube	shoulder screw	1
93-038 085-43/000	Motordeckel	motor cover	1
93-038 101-05/000	Klemmbügel	clamp strap	2
93-038 102-91/000	Fadenhebel mit Schwinge	thread take-up lever with rocking arm	2
<u>93-038 104-05/000</u>	Zahnriemen	toothed belt	2
93-038 111-45/000	Buchse	Sleeve	2
93-038 113-05/000	Kalottenlager	cap bearing	2
93-038 114-05/000	Drehfeder	torsion spring	2
93-038 115-91/000	Kurbel mit Hubexcenter	crank with feed lifting	3
93-038 118-05/000	Scheibe	washer	2
93-038 122-91/000	Riemenrad	belt pulley	2
93-038 123-91/000	Armwelle mit Zahnscheibe	arm shaft with crown wheel	2
93-038 129-44/000	Handrad	hand wheel	2
93-038 130-91/000	Spulenträger kpl.	bobbin base cpl.	2
93-038 131-05/000	Spulenträger	bobbin base	2
93-038 132-05/000	Spulergelenk	bobbin joint	2
93-038 134-05/000	Klinke	latch	2
93-038 135-05/000	Drehfeder	torsion spring	2
93-038 136-05/000	Drehfeder	torsion spring	2
93-038 137-15/000	Platte	plate	3
93-038 140-05/000	Bolzen (z. Lüfterhebel)	bolt (for foot lifter)	1
93-038 142-45/000	Aufnahme Unterteil	receiver lower part	1
93-038 143-45/000	Aufnahme Oberteil	receiver upper part	1
93-038 147-91/000	Lenker kpl.	guide cpl.	2
93-038 149-05/000	Bügefeder	frame spring	7
93-038 165-91/000	Einfädler kpl.	needle threader cpl.	2

	Bezeichnung	Description	Seite / page
93-038 166-91/000	Pendel m. Einfädler (u. Nadelst. kpl.)	pendulum with needle threader (and needle bar cpl.)	2
<u>93-038 167-91/000</u>	Einfädlerhalter kpl. m. Achse	needle threader holder cpl. with axle	2
93-038 170-45/000	Einfädlerstaste	needle threader key	2
<u>93-038 180-91/000</u>	Einfädlerhalter kpl.	needle threader holder cpl.	2
<u>93-038 251-43/000</u>	Kappe	cap	2
93-038 297-91/000	Greiferlager kpl.	hook bearing cpl.	4
93-038 297-91/000		hook cpl.	4
93-038 305-05/000	Buchse	bearing bushing	4
93-038 311-05/000	Klemmbügel	clamp strap	3, 4
93-038 312-05/000	Greiferantriebswelle	hook drive shaft	4
93-038 313-05/000	Anlaufscheibe	thrust washer	4
93-038 314-05/000	Kalottenlager	cup bearing	3, 4
93-038 324-45/000	Schieber	slider	5
93-038 325-45/000	Hebel	lever	5
93-038 336-05/000	Klemmplatte	clamping plate	4
93-038 337-45/000	Hülse	bush	4
93-038 342-91/000	Transporteurtr. m. Buchsen kpl.	feed bar bracket with bushes cpl.	4
93-038 348-91/000	Nockenhebel kpl.	cam lever cpl.	4
93-038 349-05/000	Lagerbolzen	bearing bolt	4
<u>93-038 359-45/000</u>	Kulissenstein	sliding block	4
<u>93-038 423-91/000</u>	Motor kpl.	motor cpl.	7
93-038 430-43/000	Schale vorn komplett	front cover cpl.	5
93-038 473-43/000	Niederhalter	holder frame	5
93-038 503-91/000	Transformator	transformer	1
93-038 903-91/000	Zubehör kpl.	accessory cpl.	6
93-039 031-43/000	Freiarmklappe	free arm flap	5
93-039 032-43/000	Freiarmdeckel	free arm cover	5
93-039 033-25/000	Scharnierfeder	hinge spring	5
93-039 040-09/000	Bodenplatte	base plate	1
93-039 101-90/000	Kofferhaube kpl.	carrying case cpl.	6
<u>93-039 108-05/000</u>	Zahnriemen	toothed belt	7
<u>93-039 225-91/000</u>	Kegelrad, treibend	bevel gear, driving	4
93-039 253-44/000	Träger	bracket	2
<u>93-039 340-44/000</u>	Stickrahmen 225	embroidery frame 225	9
<u>93-039 351-05/000</u>	Schablone	template	9
93-039 442-05/000	Lagerbolzen	bearing bolt	4
93-039 450-91/000	Transporteur kpl.	feeder cpl.	4
93-039 455-91/000	Hubhebel kpl.	lifting lever cpl.	4
93-039 903-91/000	Zubehör kpl.	accessory cpl.	6
<u>93-039 910-35/000</u>	Stichplatte	needle plate	1
93-040 060-05/000	Zyl. Druckfeder	helical compression spring	1
93-040 184-15/000	Benzing-Clip U93	Benzing-Clip U93	2
93-040 206-05/000	Zyl. Druckfeder	helical compression spring	2
93-040 207-15/000	Druckstift	pressure pin	2
93-040 294-91/000	Bolzen kpl.	bolt cpl.	3
93-040 654-05/000	Zyl. Zugfeder	tension spring	2
93-041 122-45/000	Fuß	foot	1
<u>93-101 815-05/000</u>	Spulerreibring	bobbin winder friction ring	2
93-107 996-05/000	Polster unten	lower padding	9
98-694 889-00/000	Schraube	screw	2
<u>98-694 886-00/000</u>	Nähfußhalter kpl.	sewing foot holder cpl.	2

Nummernverzeichnis • Numerical Index • Index • Elenco dei Numeri • Índice numérico

Bezeichnung

Description

Seite / page

PFAFF

Technische Änderungen vorbehalten

Subject to alterations in design

Sous toute réserve de modifications techniques

Salvo modificaciones técnicas

Con riserva di modifiche tecniche

Nr. 104 22 61-96

© 2011 Copyright VSM Group AB
All rights reserved