

SINGER SEWING MACHINE COMPANY

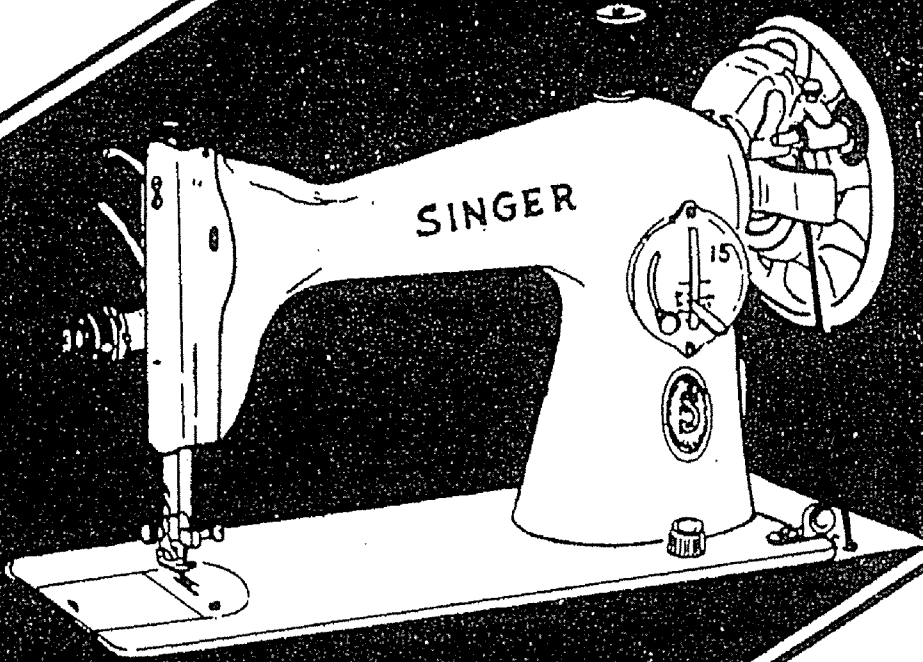

15_{CH}

SINGER*

MODELS—1 AND 11

1208.

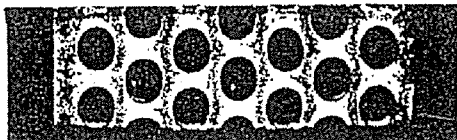

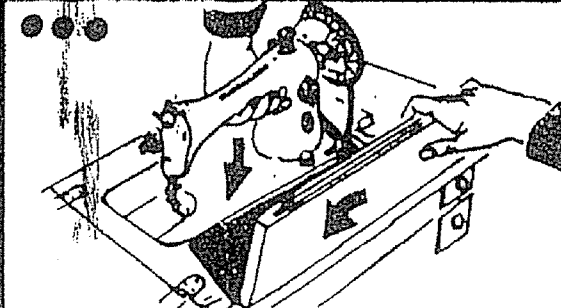
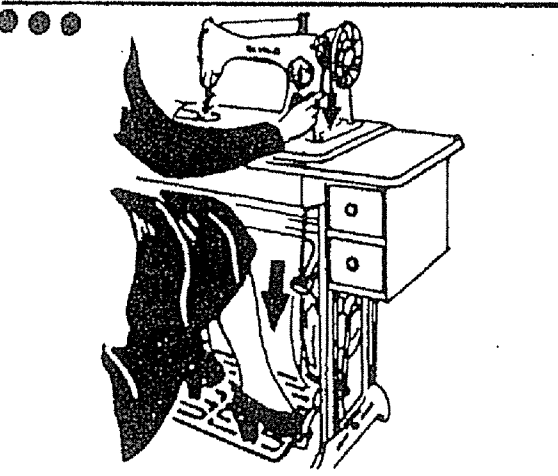
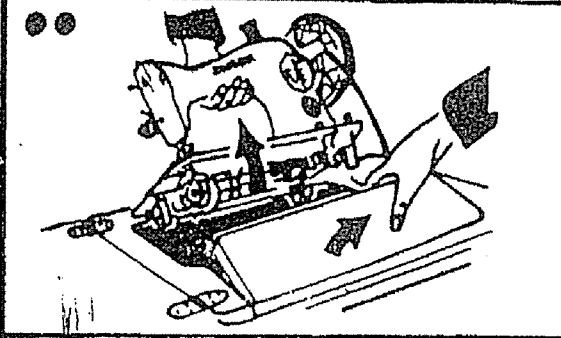
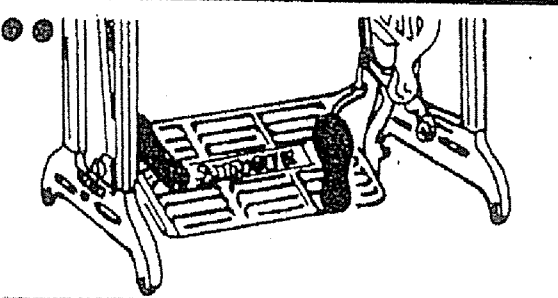
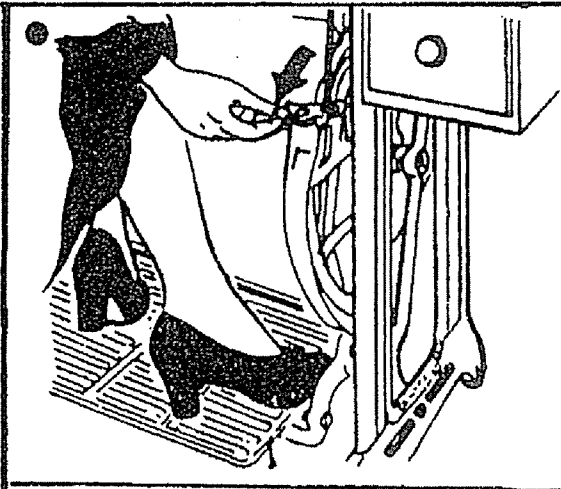
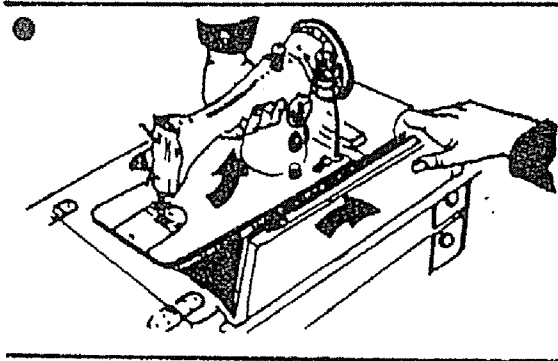
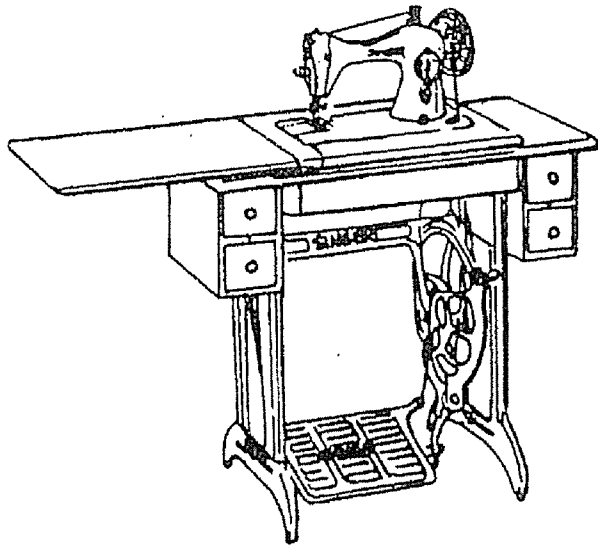

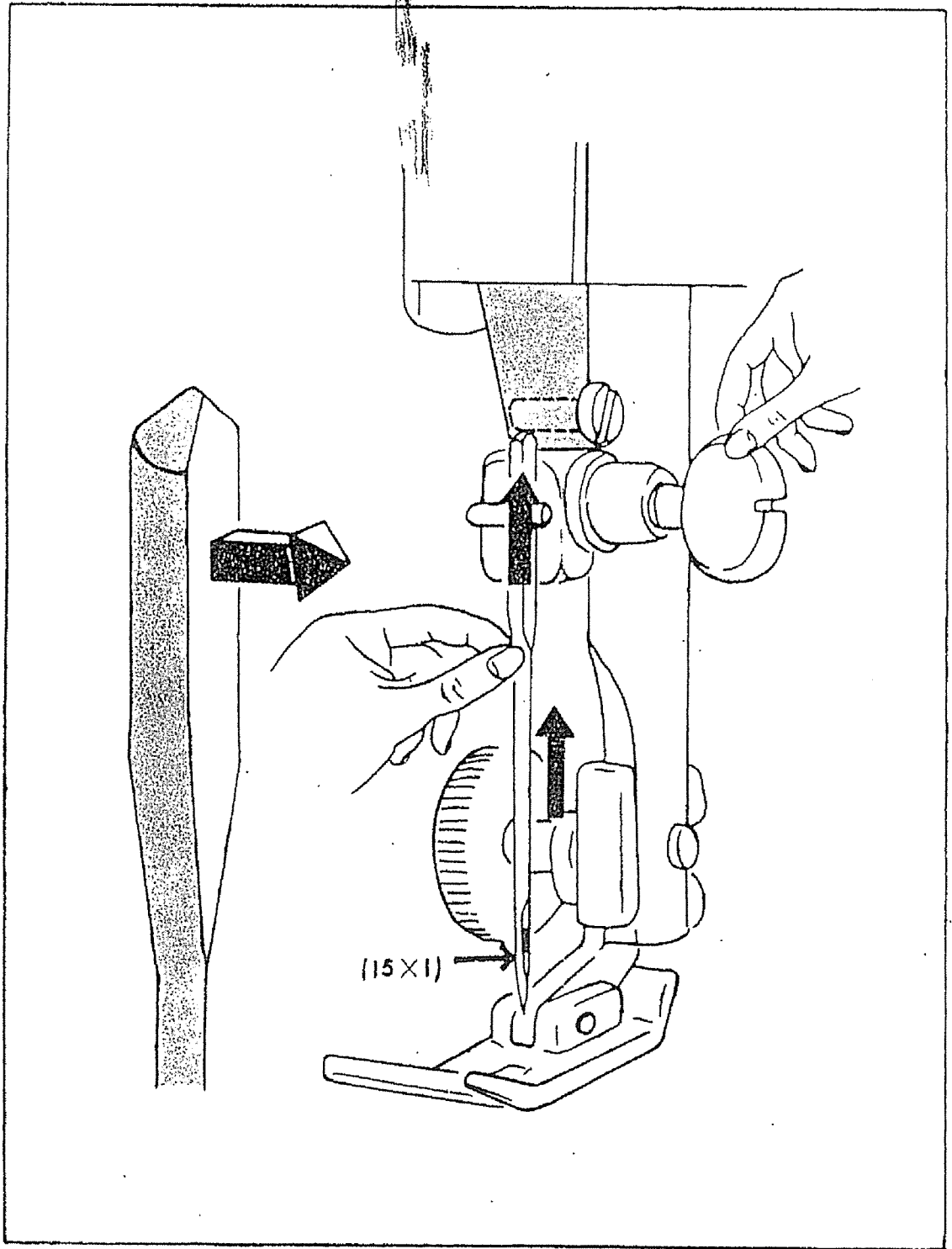

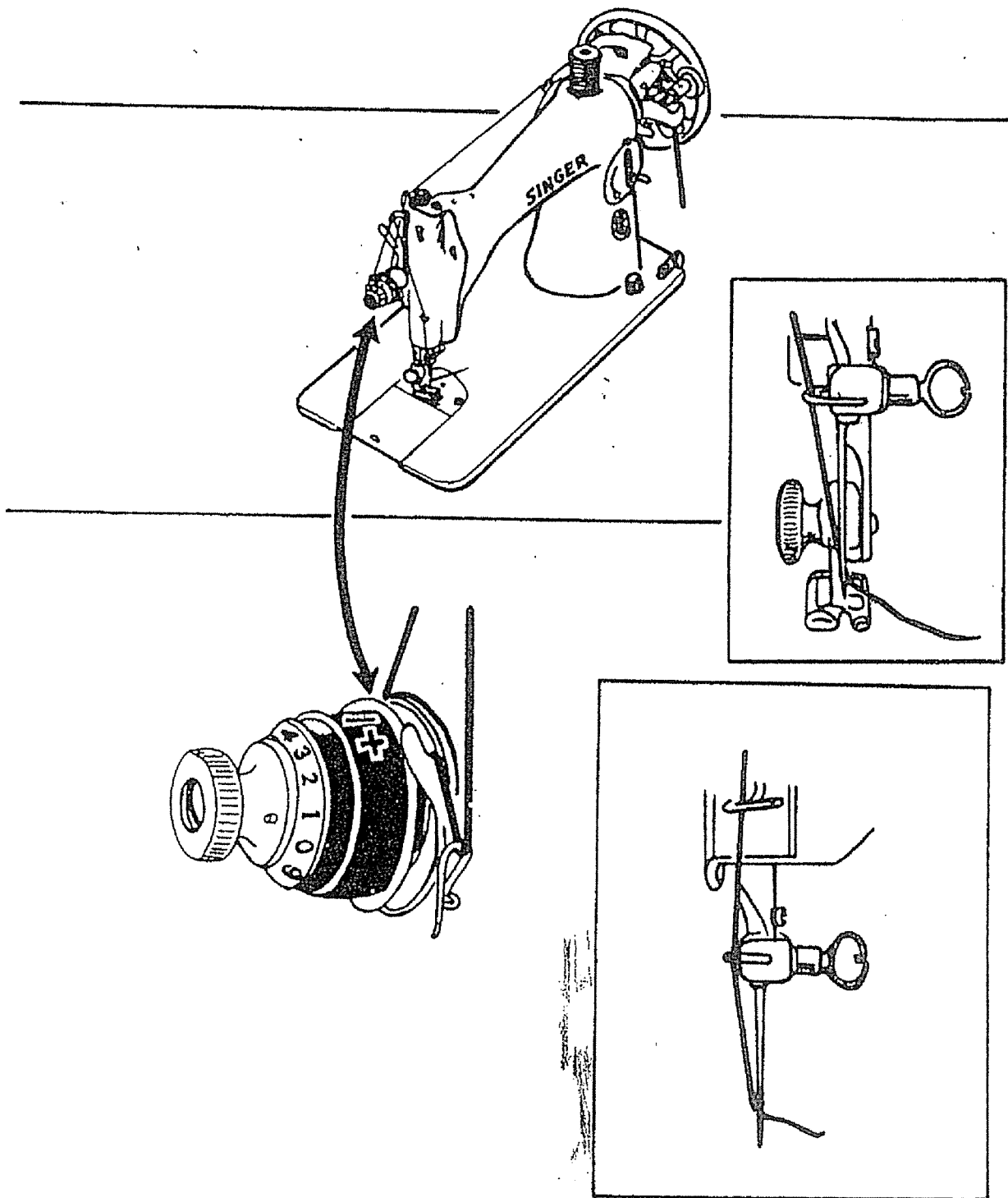

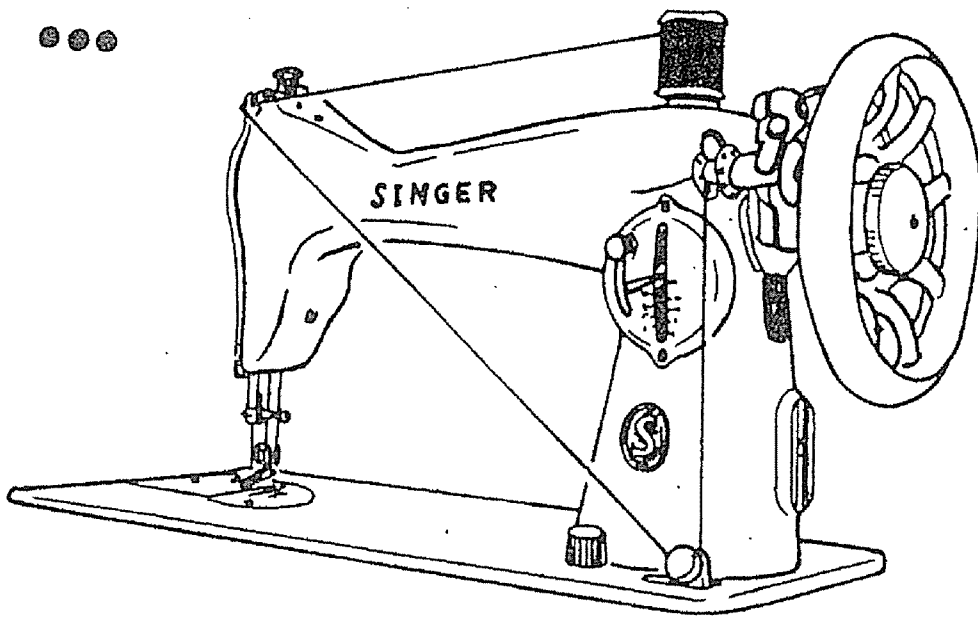
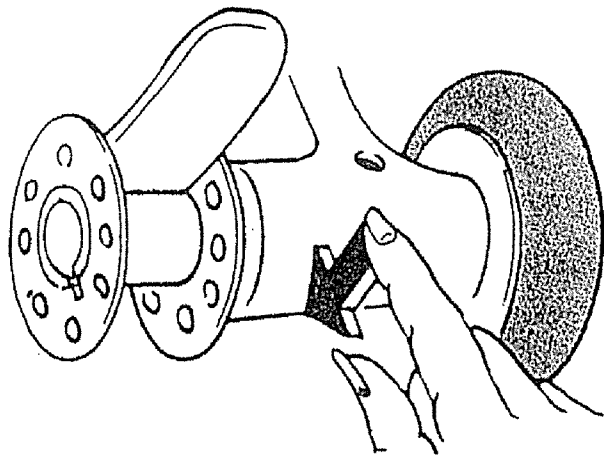
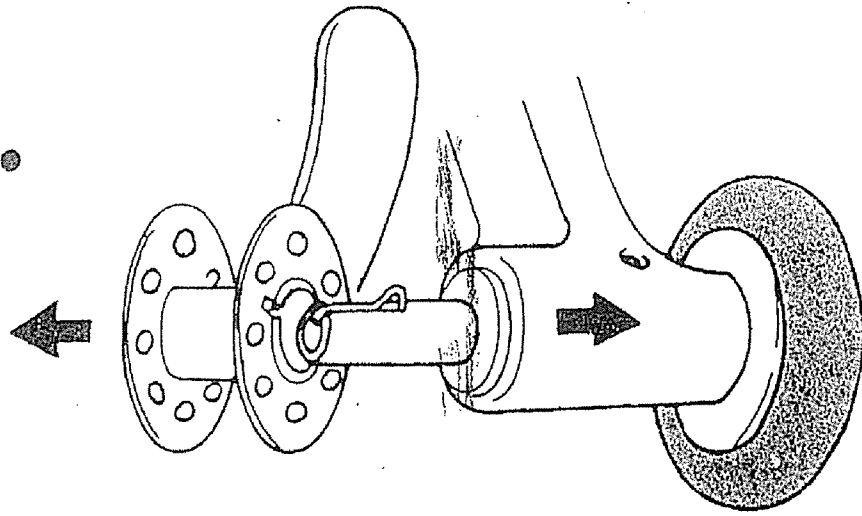

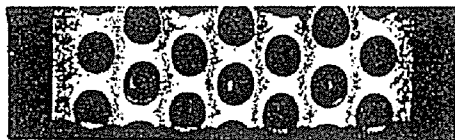
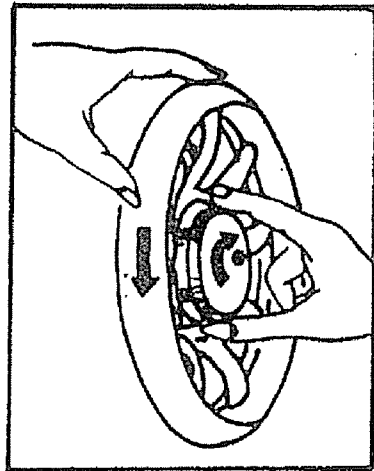
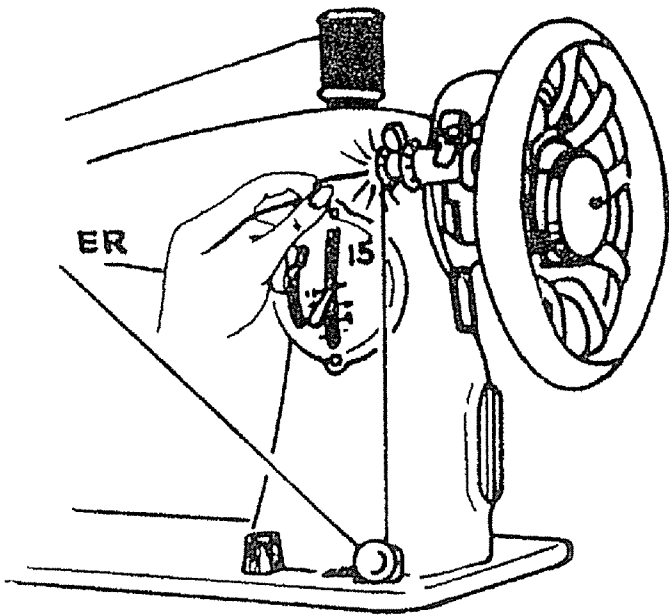
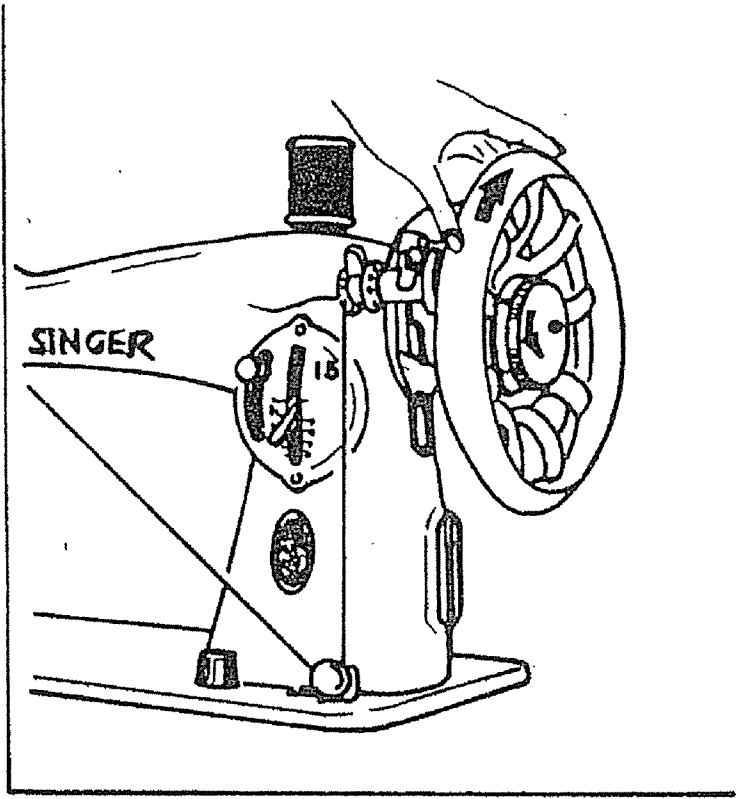

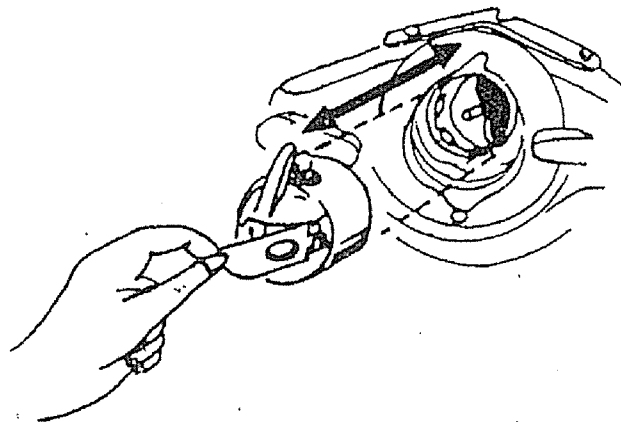
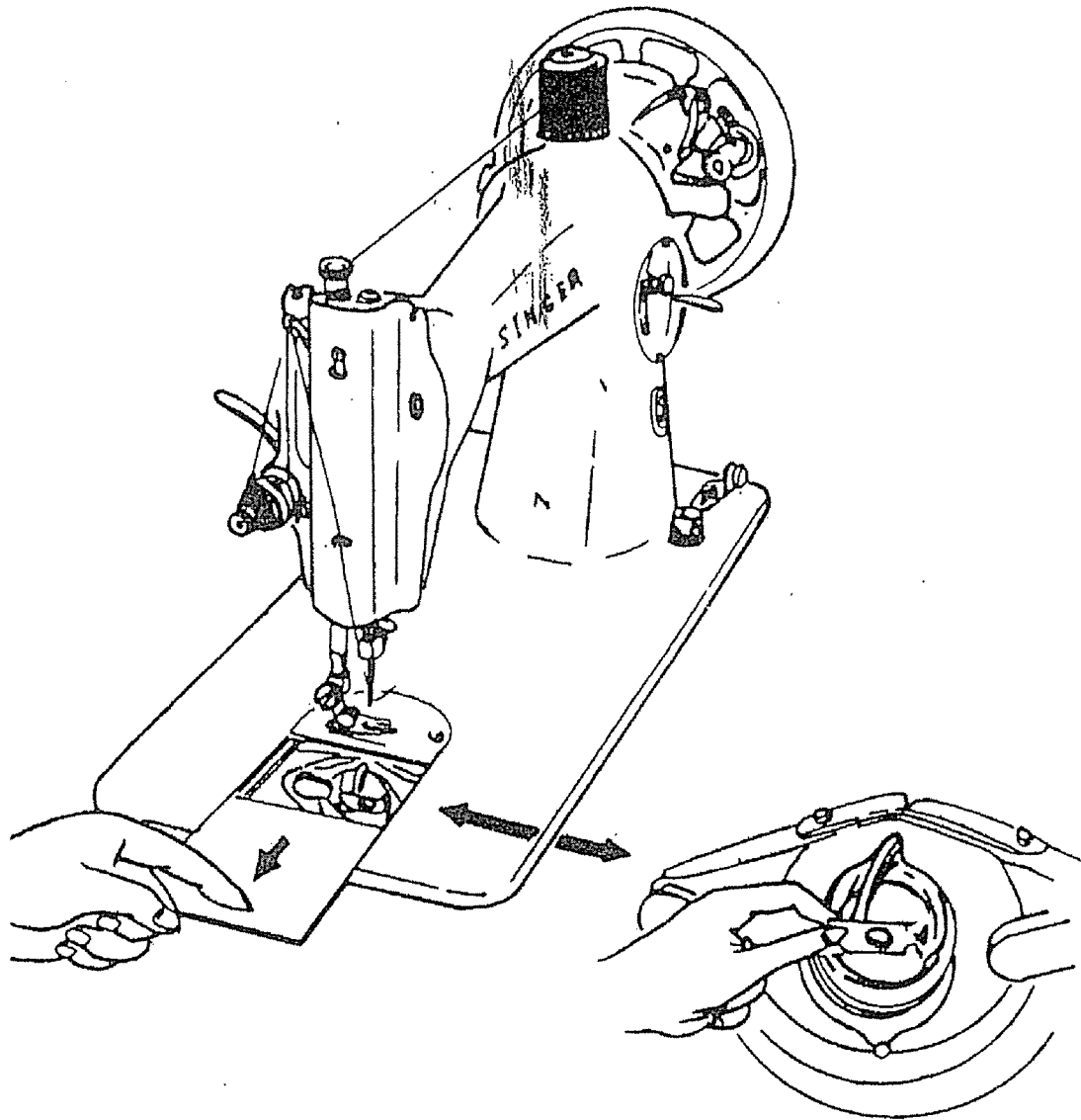

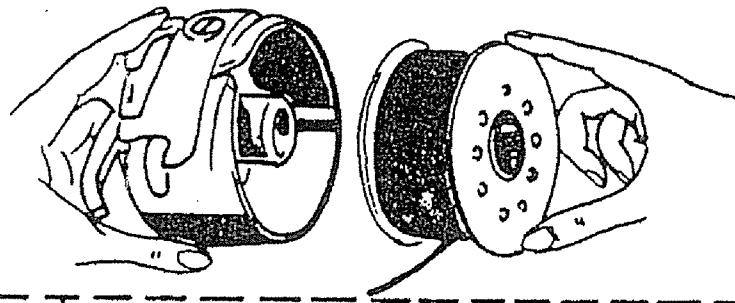

• •

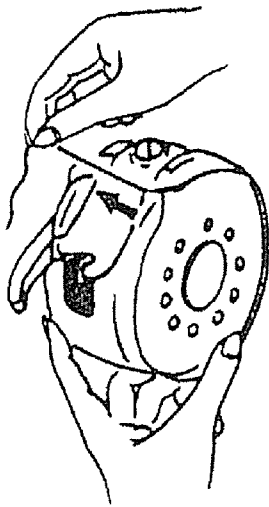

• • •



• • • •

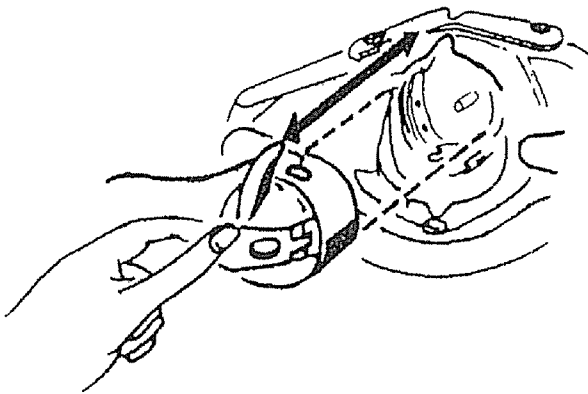

• • • • •

